

Cleaning Tool

for Primado2 Attachments

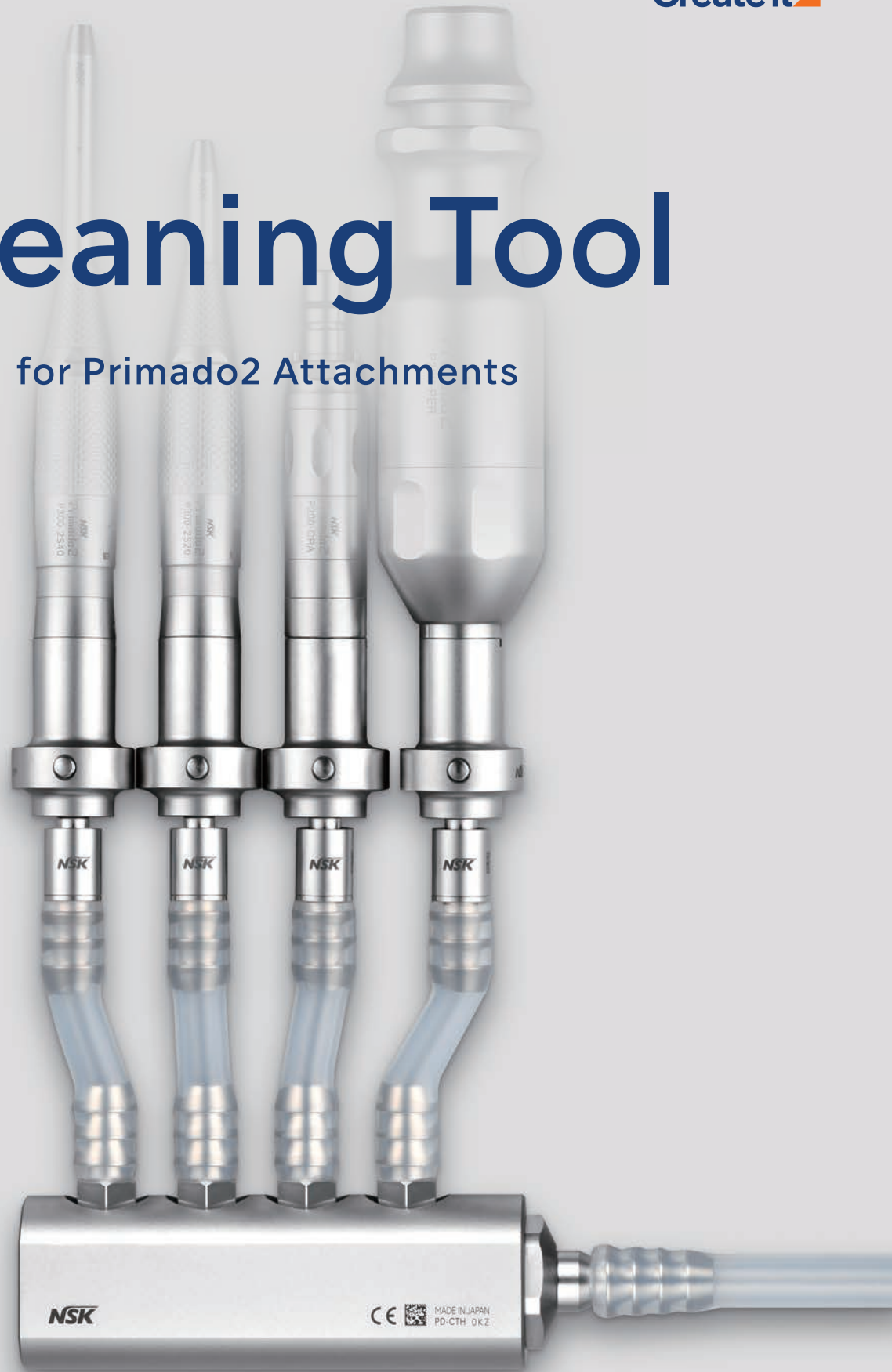

Primado2
Total Surgical System

Efficient cleaning of contaminants in the lumen

Reduce the risk of excessive heat development and malfunction of attachments due to insufficient cleaning



Contaminants in the lumen

Specially designed Cleaning Holder

Maintains balance of flow rate in each outlet

Comparison table of flow rate*

- Controlled Design
- Uncontrolled Design

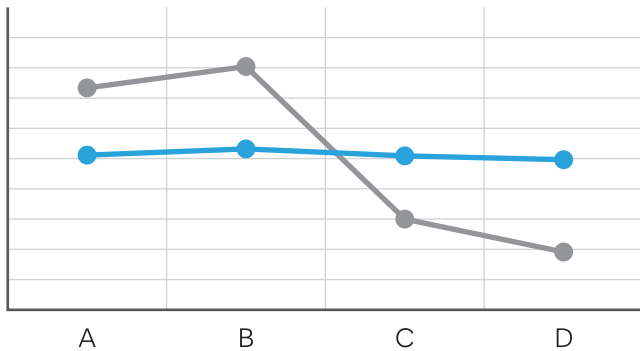

*Based on the result of in-house testing

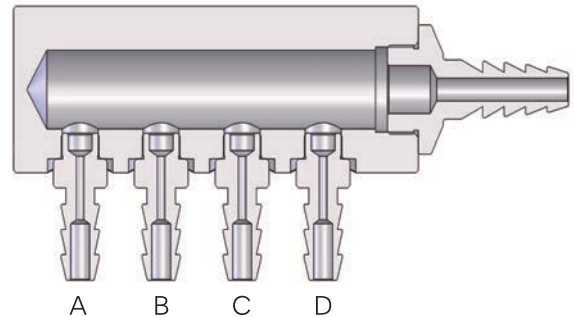

Choice of cleaning options

Manual cleaning





Washer disinfectant

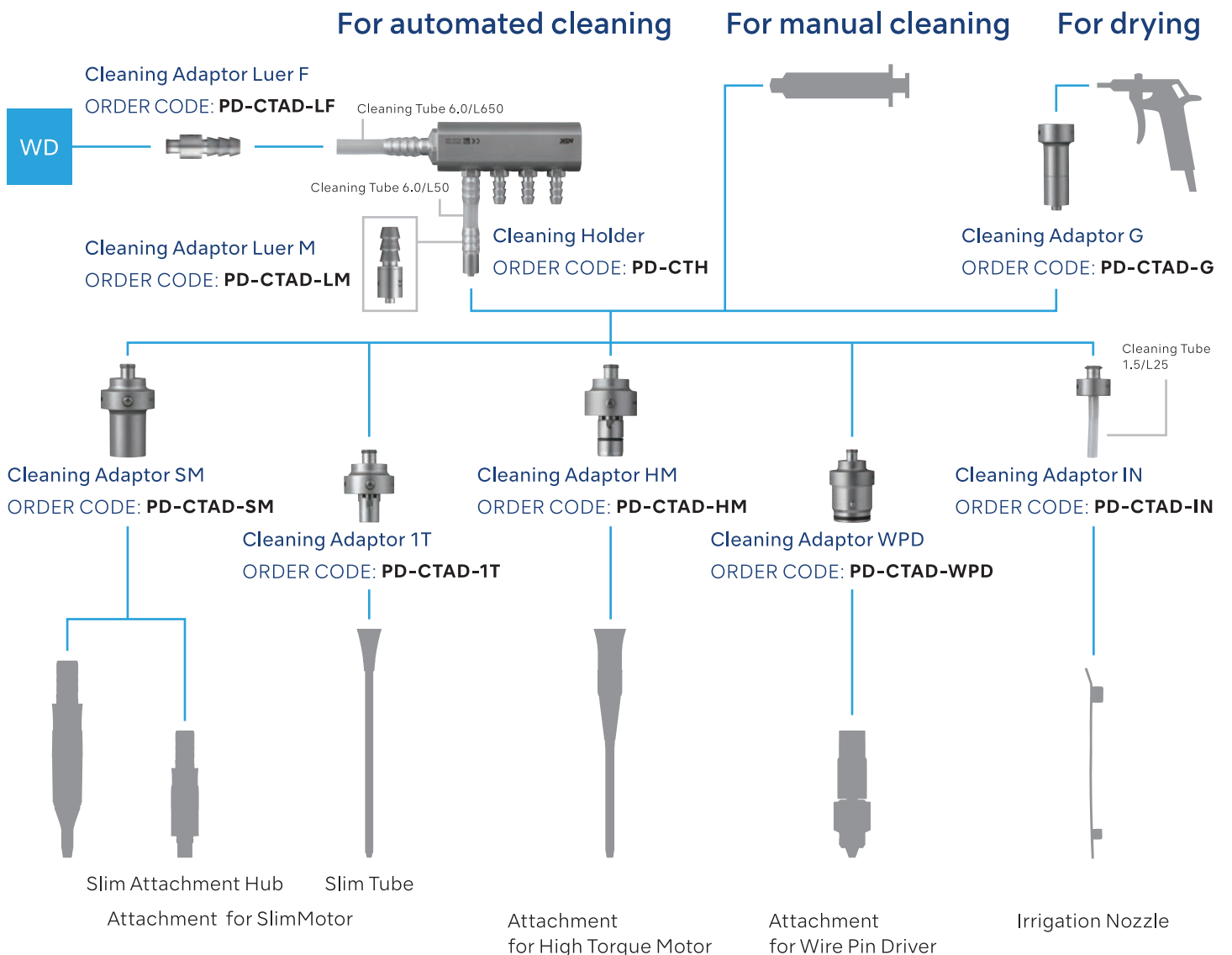
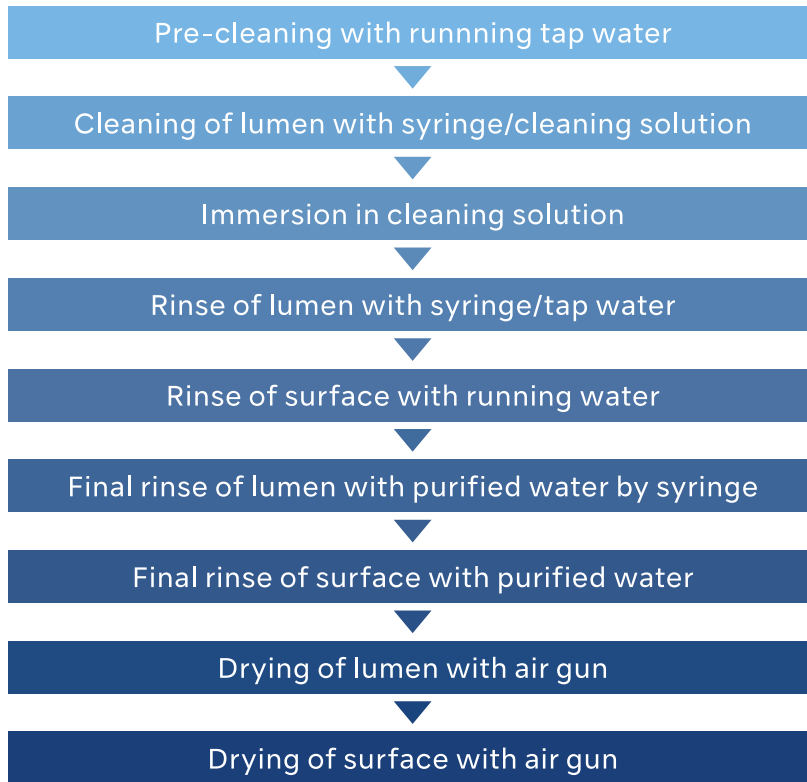

Cleaning process steps for manual cleaning



*Please be sure to read the reprocessing manual. *These Cleaning Tools can not be used with the Bone Saw Attachment

Description		Order code	
Cleaning Holder		PD-CTH	Bundled Item: PD-CTTU-606501 PD-CTTU-600504
Cleaning Adaptor Luer M		PD-CTAD-LM	
Cleaning Adaptor Luer F		PD-CTAD-LF	
Cleaning Adaptor SM		PD-CTAD-SM	
Cleaning Adaptor 1T		PD-CTAD-1T	
Cleaning Adaptor IN		PD-CTAD-IN	Bundled Item: PD-CTTU-150252
Cleaning Adaptor HM		PD-CTAD-HM	
Cleaning Adaptor WPD		PD-CTAD-WPD	
Cleaning Adaptor G		PD-CTAD-G	
Cleaning Tube 6.0/L650		PD-CTTU-606501	
Cleaning Tube 6.0/L50		PD-CTTU-600504	
Cleaning Tube 1.5/L25		PD-CTTU-150252	
EZ Spray Adaptor		PD-EZ-M	
Spray Adaptor for Slim		P200-EZ-SM	
Spray Adaptor for Bone Saw		P200-EZ-BM	
Spray Adaptor for WPD		P200-EZ-WPD	
PANA SPRAY Plus		Z182100	